

ENERGIZER CR2320

Lithium Coin



Industry Standard Dimensions

mm (inches)



This Battery has Underwriters Laboratories component Recognition

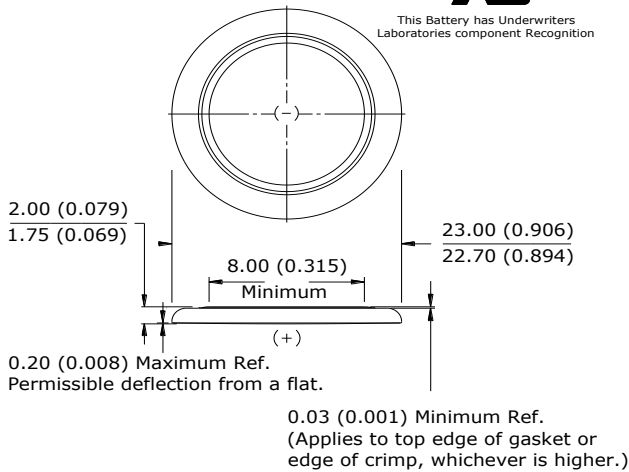

Simulated Application test

Typical Performance at 21°C (70°F)

Schedule:	Typical Drains: at 2.9V (mA)	Load (ohms)	Cutoff 2.0V (hours)
Continuous	0.29	10,000	466

Typical Discharge Characteristics

Load: 10K ohms - Continuous
Typical Drain @ 2.9V: 0.29 mA

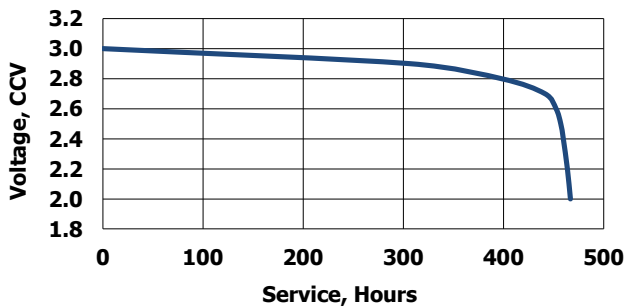

Internal Resistance Characteristics

Pulse Test at 21°C (70°F)

Bkgnd Drain: Continuous
10K ohms
0.29 mA @2.9V

Pulse Drain: 2 seconds X 12 times/day
400 ohms
6.8 mA @2.7V

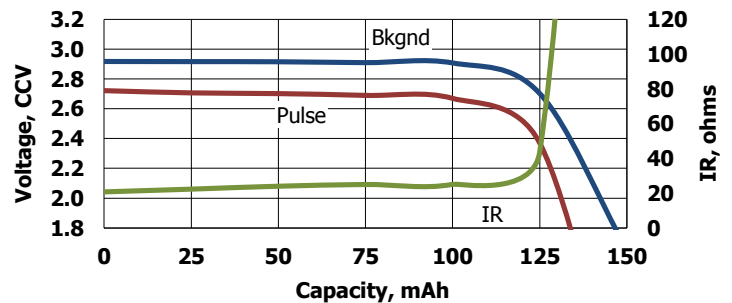

Important Notice

This datasheet contains typical information specific to products manufactured at the time of its publication.
©Energizer Holdings, Inc. - Contents herein do not constitute a warranty.



Safety:

(1) KEEP OUT OF REACH OF CHILDREN. Swallowing may lead to serious injury or death in as little as 2 hours due to chemical burns and potential perforation of the esophagus. **Immediately see doctor; have doctor phone (202) 625-3333.**

(2) Battery compartment design. To prevent children from removing batteries, battery compartments should be designed with one of the following methods: a) a tool such as screwdriver or coin is required to open battery compartment or b) the battery compartment door/cover requires the application of a minimum of two independent and simultaneous movements of the securing mechanism to open by hand. Screws should remain captive with the battery door or cover.