

Specifications:

Sound level Category	Loud Sound Level
Mode of Operation	Continuous Sound/Flashing LED
LED Operation (PPS)	2 ± 1.5
Mounting	Panel (see note B)
Voltage Rating	60 to 250 Vac/dc
Frequency	2900 Hz ±500 Hz
Loudness (Min. Voltage)	82 dB(A) min. @ 2 FT and 60 Vac/dc
Loudness (Max Voltage)	90 dB(A) min. @ 2FT and 250 Vac/dc
Current Draw	42 mA Max @ 60 Vac/dc
Current Draw	61 mA Max @ 250 Vac/dc
Storage Temperature	-40°C to +85°C
Operating Temperature	-30°C to +65°C
Weight (Typical)	2.1 oz (59 g)
Housing	6/6 Nylon, Color Black
Options	For other options contact factory

Dimensions: Inches (mm)

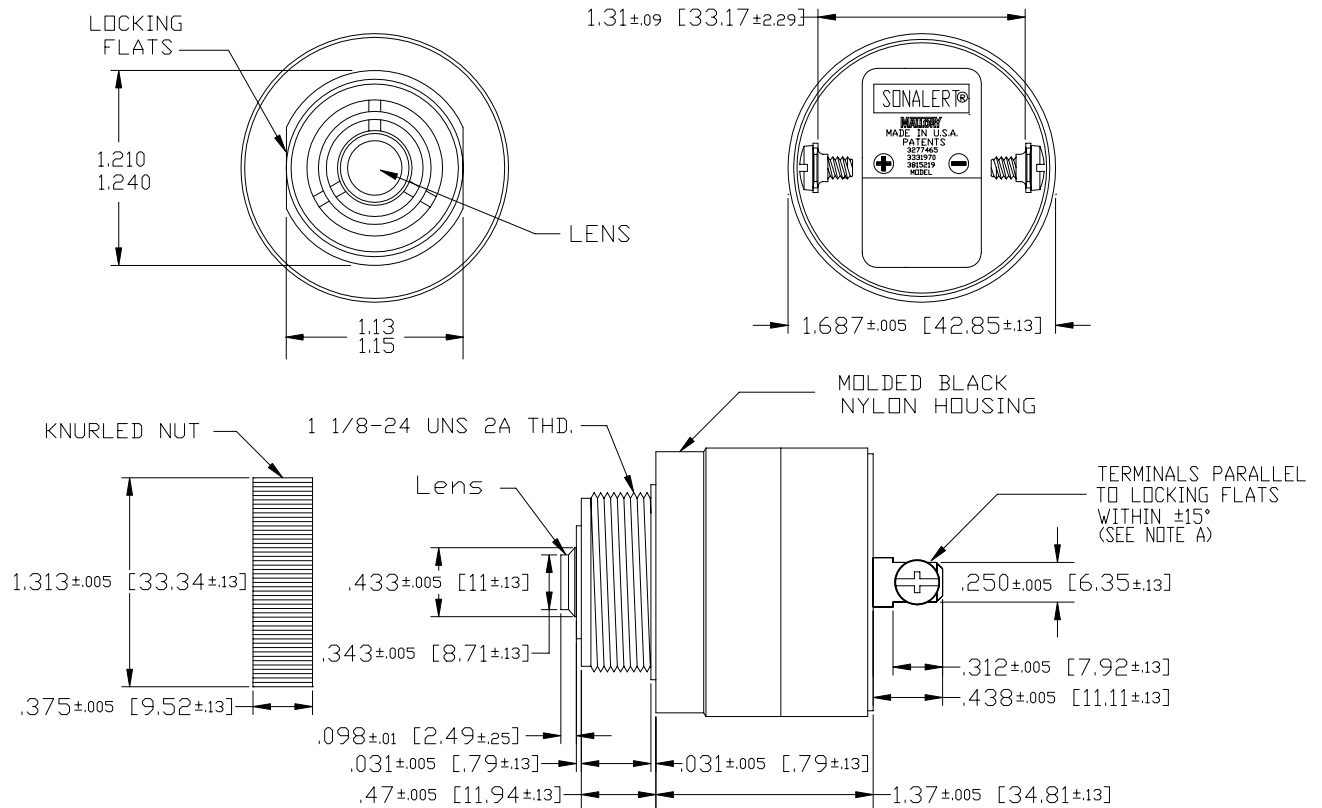

NOTE A: TERMINALS-.032 BRASS TIN PLATED, TAPPED FOR #6-32 SCREW. TWO #6-32 NICKEL PLATED BRASS SCREWS INCLUDED. WILL ACCEPT 1/4" QUICK CONNECT.

NOTE B: MOUNTING- REMOVE BLACK PLASTIC NUT AND INSERT THREADED FRONT THROUGH 1.25" HOLE PUNCHED IN PANEL, IF ORIENTATION IS NEEDED, NOTE LOCKING FLATS ON DRAWING. SCREW NUT BACK ON. DO NOT OVERTIGHTEN.